

Kit 3069

- FORD Mondeo (Mk.II.), 4-dr Sedan, 01-07
- FORD Mondeo (Mk.II.), 5-dr Hatchback, 01-07
- MAZDA Atenza (Mk.I.), 4-dr Sedan, 02-07
- MAZDA Atenza (Mk.I.), 5-dr Hatchback, 02-07
- MAZDA Atenza (Mk.II.), 4-dr Sedan, 08–
- MAZDA Atenza (Mk.II.), 5-dr Hatchback, 08–
- MAZDA Axela, 4-dr Sedan, 04-08
- MAZDA Axela, 5-dr Hatchback, 04-08, 09–
- MAZDA CX-7, 5-dr SUV, 07–
- MAZDA CX-9, 5-dr SUV, 07–
- MAZDA Demio, 5-dr Hatchback, 07–
- MAZDA 2, 5-dr Hatchback 07–
- MAZDA 3, 4-dr Sedan, 04-08 / *04-09, 10–
- MAZDA 3, 5-dr Hatchback, 04-08, 09– / *04-09, 10–
- MAZDA 6 (Mk.I.), 4-dr Sedan, 02-07 / *03-08
- MAZDA 6 (Mk.I.), 5-dr Hatchback, 02-07 / *02-04, 05-07
- MAZDA 6 (Mk.II.), 4-dr Sedan, 08–
- MAZDA 6 (Mk.II.), 5-dr Hatchback, 08–

*North America

This Kit is only for vehicles with fixpoint mounting.

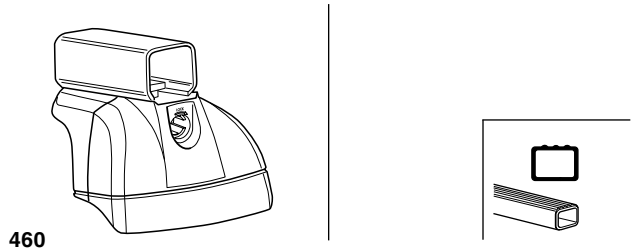
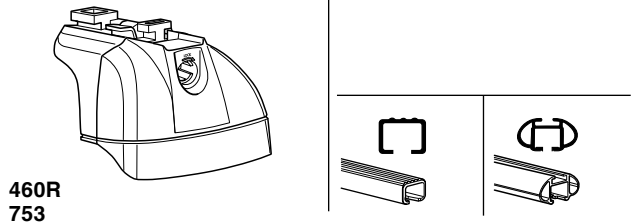

xx kg
 xx lbs + 5 kg
 11 lbs = **Max. 75kg**
Max. 165 lbs

80 km/h 130 km/h
 50 Mph 80 Mph
 40 km/h 25 Mph
km/h Mph

+ **Kit XXXX**

A **B** **C**

04 x 4

03 x 2

04 x 2

x 1

50962

27 mm x 4

x 4

x 4

x 4

x 1 3 mm

x 1

Kit



753

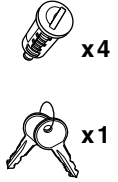
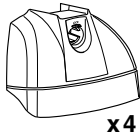

460R

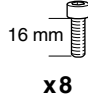
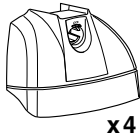
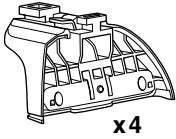

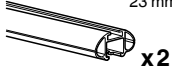
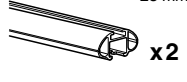
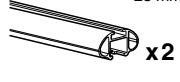
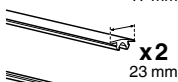
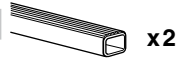
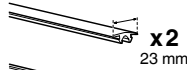
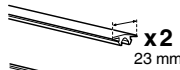
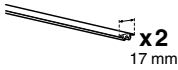
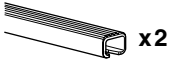
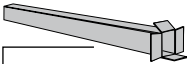
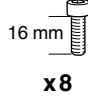
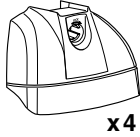
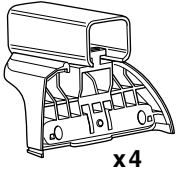

460

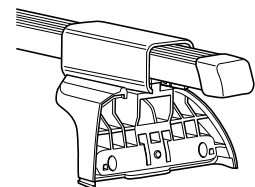
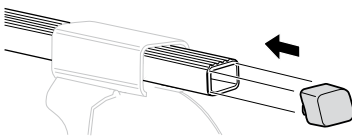
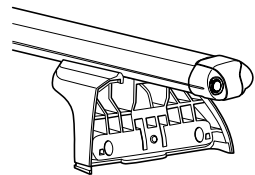
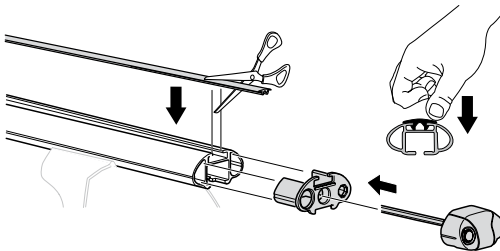
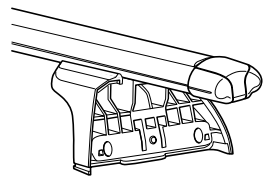
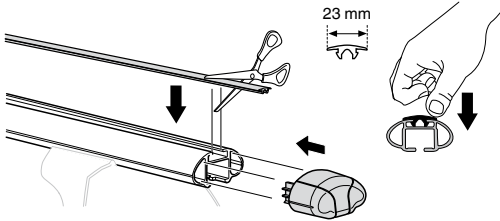
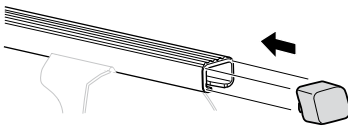
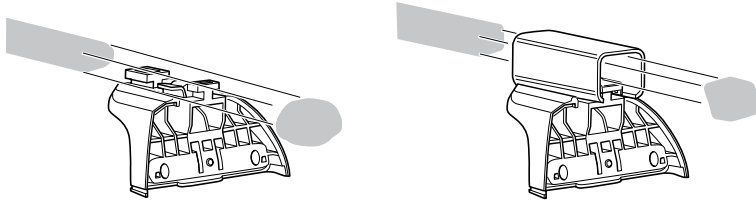
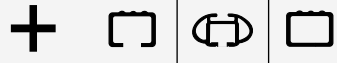

1

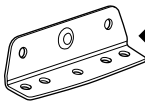
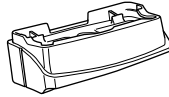

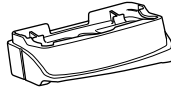
2◀ **04** x 4◀ **03** x 216 mm  x 8◀ **04** x 2

x 1

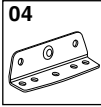
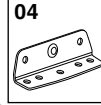
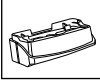
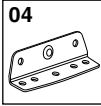
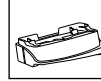
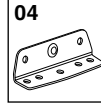
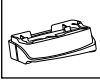
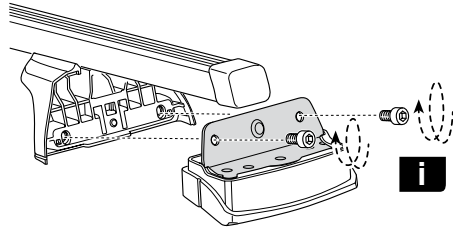
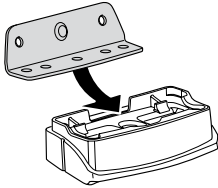
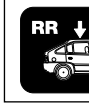
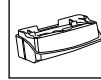
**03****04****04****03****i**

GB Only a few turns
D Nur wenige Umdrehungen
F Quelques tours uniquement
NL Slechts enkele slagen
I Solo qualche giro
E Sólo algunas vueltas
PT Noções básicas
S Endast några varv
FIN Vain muutama kierros

EST Ainult mõni pööre
LAT Tikai dažī apgriezieni
LIT Tik keli pasukimai
PL Wystarczy kilka obrotów
RU Достаточно нескольких оборотов
CZ Pouze několik otáček
SK Len niekoľko otáčok
SLO Le nekaj obratov

HR Samo nekoliko okreta
HU Csak néhány fordítás
GR Μόνο μερικές στροφές
TR Yalnız birkaç kez çevirm
中文 只有几个转向
한국어 두 세번만
日本語 数回転のみ
ไทย หมุนเพียงไม่กี่รอบ

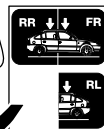
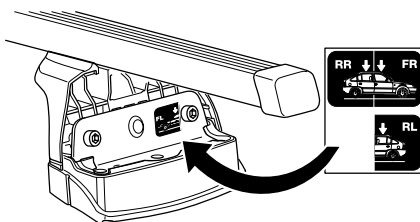

3

x 4



x 4



x 4



x 4

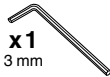

x 1

3 mm

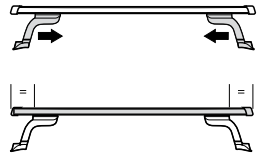
**A**

FORD

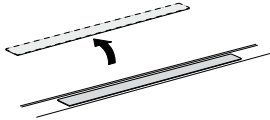

MAZDA

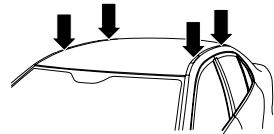
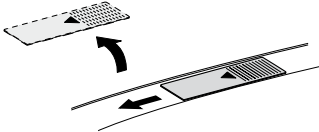
**B**

FORD

2 Nm

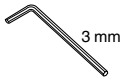

3 mm

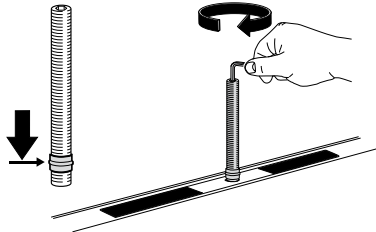

MAZDA

2 Nm

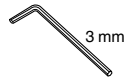

3 mm

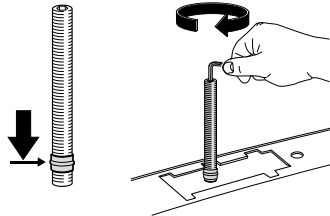
**C**

FORD

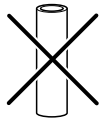

MAZDA

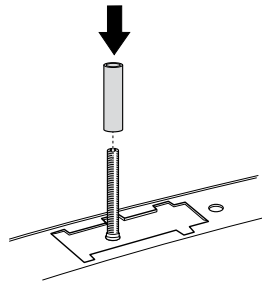
**D**

FORD

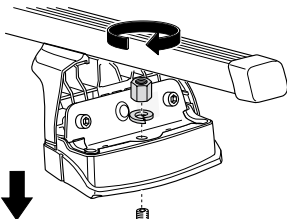

MAZDA

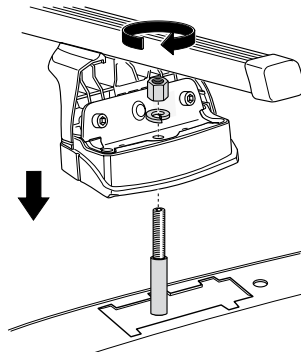

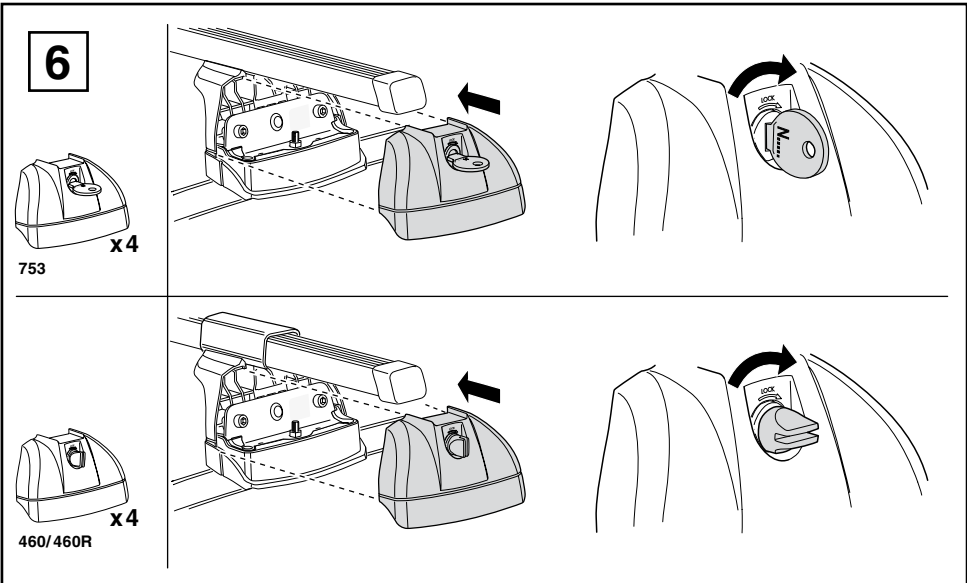
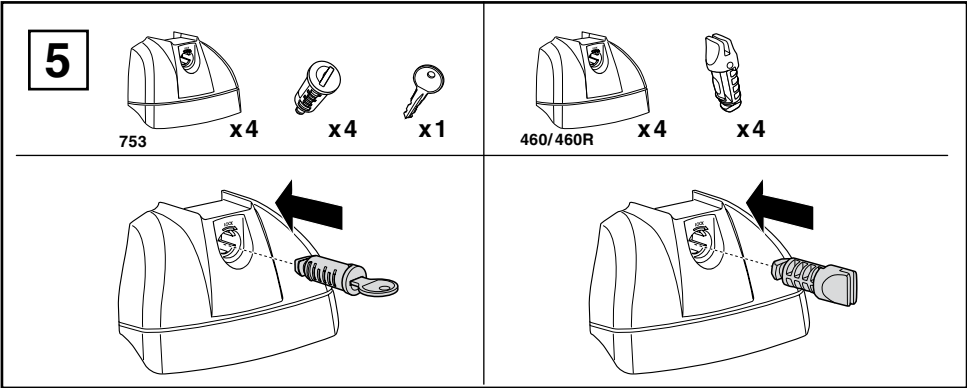
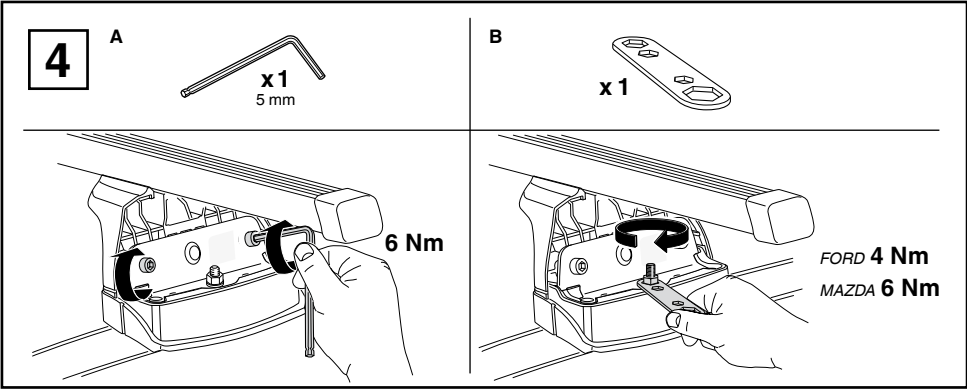

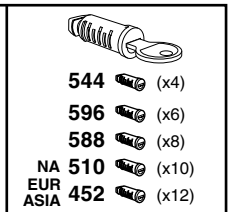

WW ▶ Thule Sweden AB, Box 69, 330 33 Hillerstorp, SWEDEN
NA ▶ Thule Inc., 42 Silvermine Road, Seymour, Connecticut 06483, USA

info@thule.com
 customer.service@thule.com

www.thule.com