



Thule XT Kit 3142

> Instructions

JEEP Grand Cherokee, 5-dr SUV, 11-

This kit is only for vehicles with fixpoint mounting.

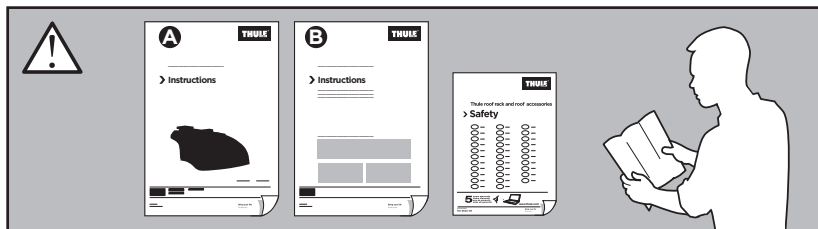

ISO 11154-E

183142

C.20140304
509-3142-01

Bring your life
thule.com

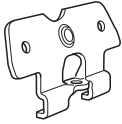

◀ **06** x4

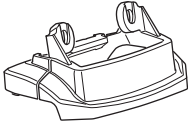

◀ **45** x2

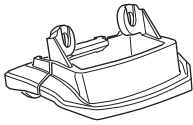
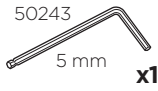

◀ **46** x2

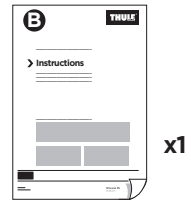
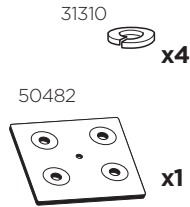
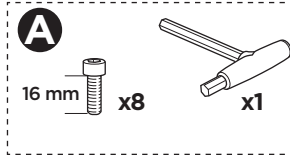

1

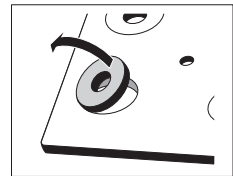
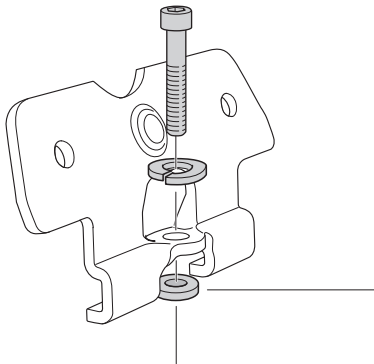
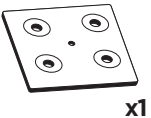
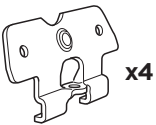

2

06



46

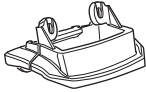

FL



FR



45



06



06



45



RL



RR



46



06



3

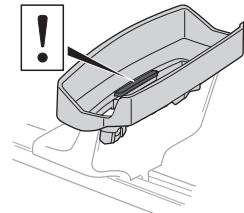
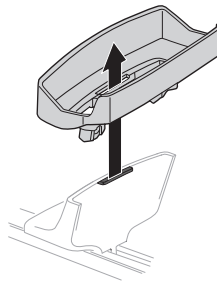
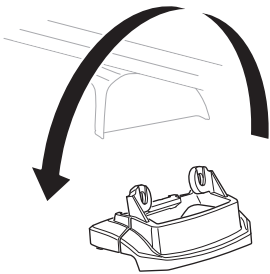

4

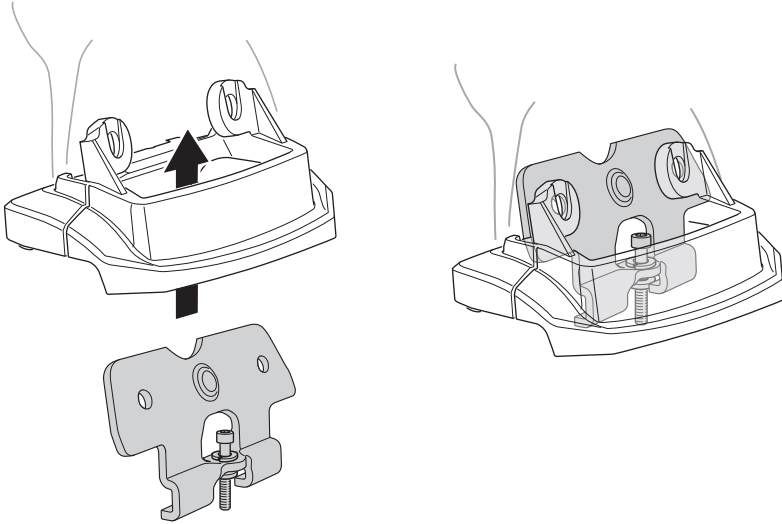

5

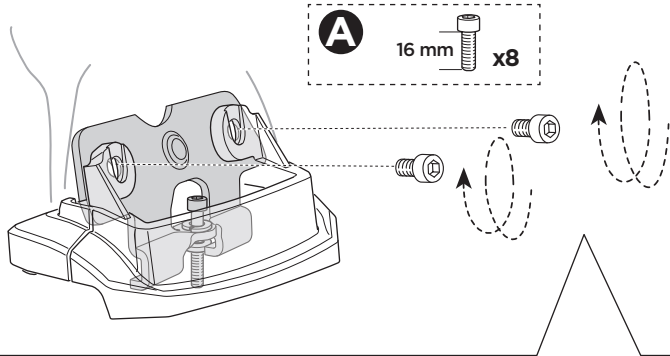

EN	Only a few turns	ET	Ainult mõni pööre	RO	Doar câteva rotiri
DE	Nur wenige Umdrehungen	LV	Tikai dažī apgriezieni	HU	Csak néhány fordítás
FR	Quelques tours uniquement	LT	Tik keli pasukimai	EL	Μόνο λίγες περιστροφές
NL	Slechts enkele slagen	PL	Wystarczy kilka obrotów	TR	Yalnızca birkaç tur
IT	Solo qualche giro	RU	Только несколько оборотов		بعض دورات فقط
ES	Sólo algunas vueltas	UK	Лише декілька обертів		רק מספר סיבובים
PT	Apenas algumas voltas	BG	Само няколко завъртания	ZH	仅几圈
SV	Endast några varv	CS	Pouze několik otáček	JA	2～3回転のみ
DK	Kun nogle få omgange	SK	Len niekoľko otáčok	KO	몇 번만 돌리면 됨
NO	Bare noen få omdreininger	SL	Le nekaj obratov	TH	เพียงสองสามรอบ
FI	Vain muutama kierros	HR/BIH	Samo nekoliko okreta		

6

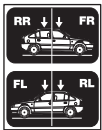

x1

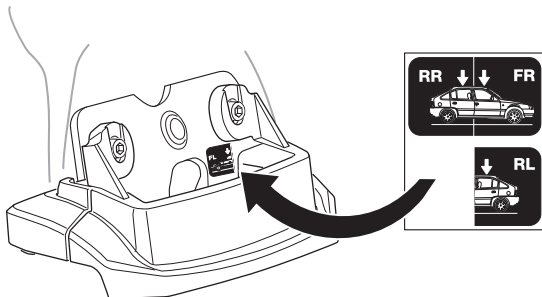

7



T30 x1

A



B

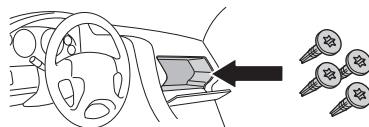
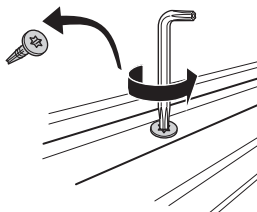

C

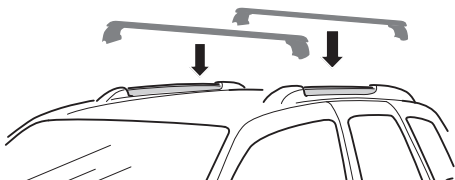

D

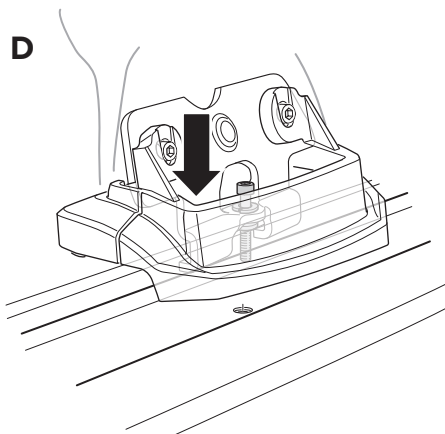

8

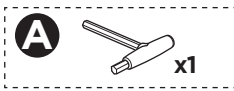

6 Nm

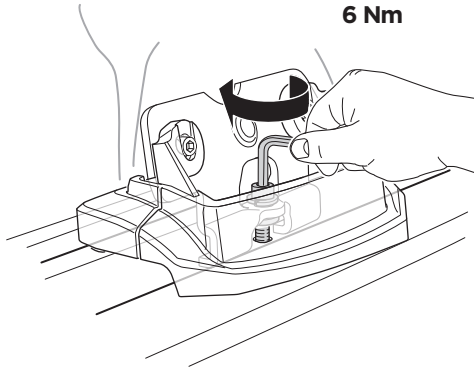

6 Nm

