

Thule Lock Kit

➤ Instructions

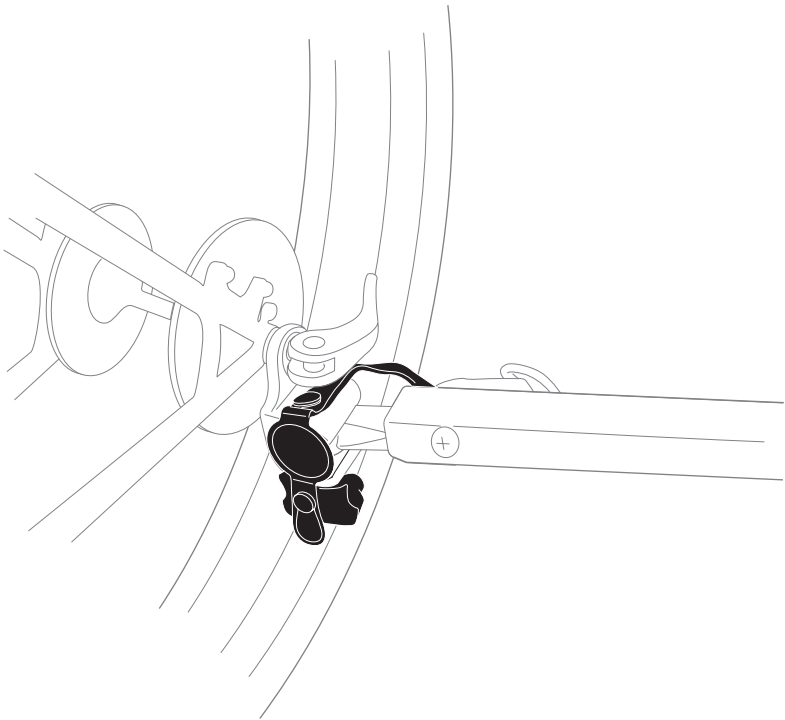

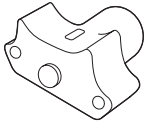

x1

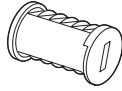

x1

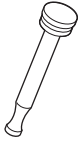
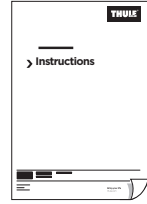

x1



x2



x1

1

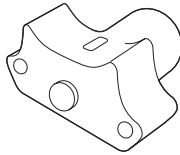

A

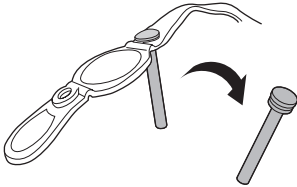

B

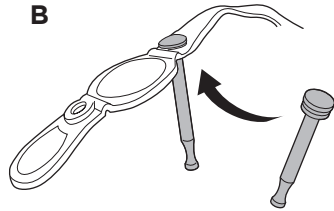

C

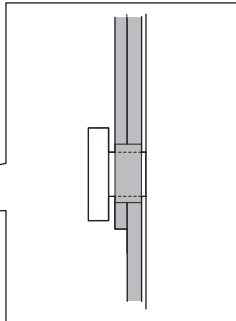
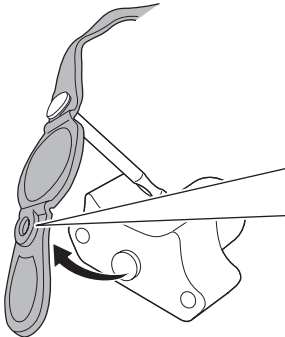

A

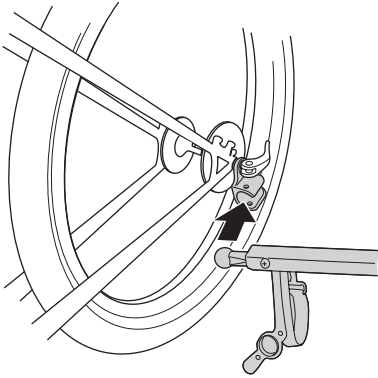

B

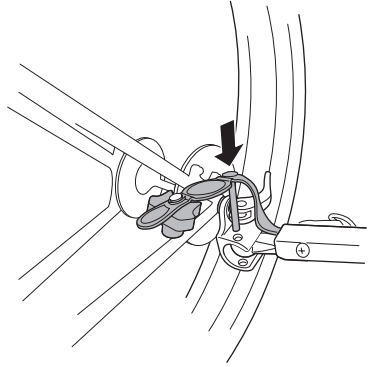

C

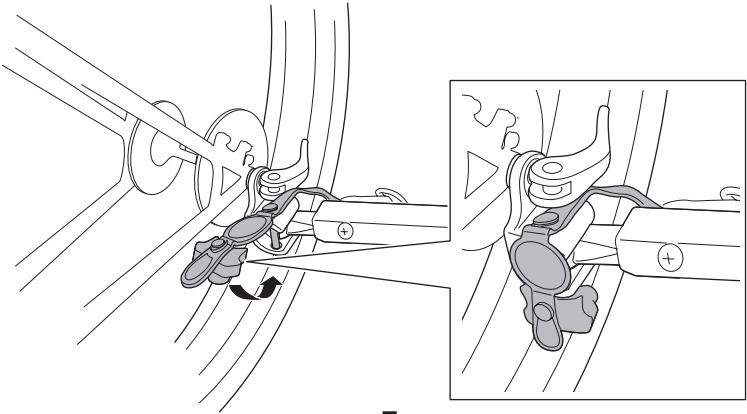

D

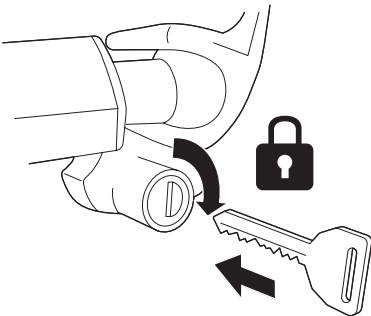

E

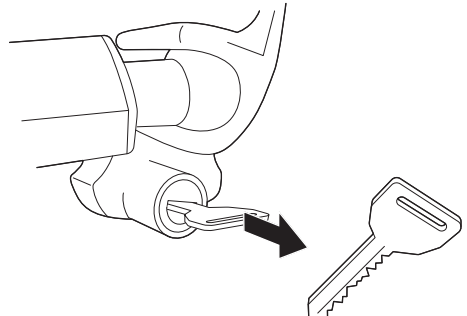

3

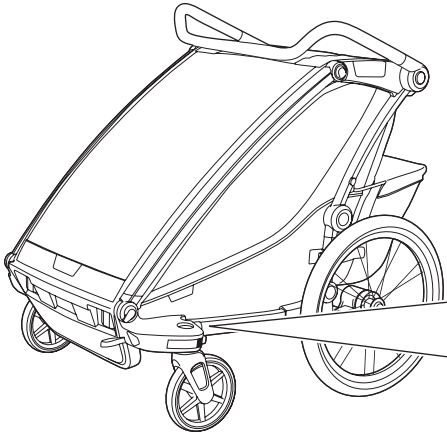

A

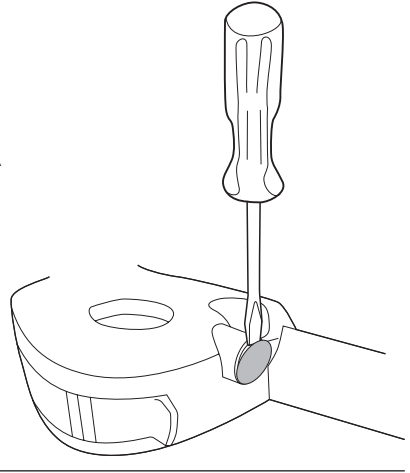

B

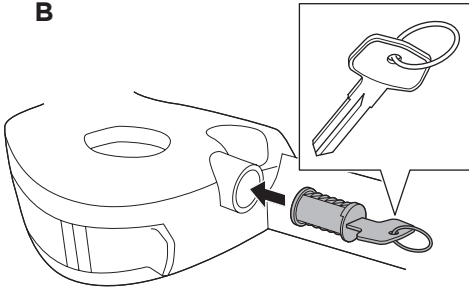

C

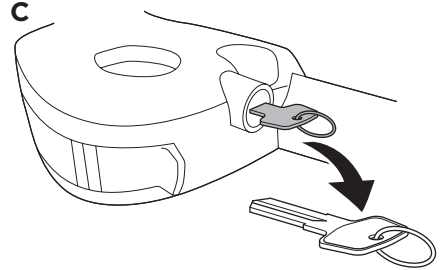

D

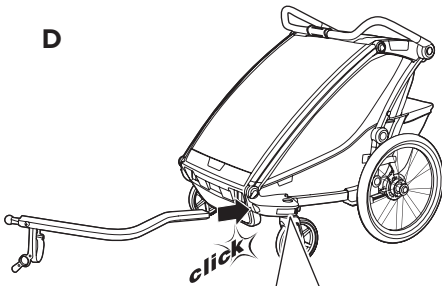

E

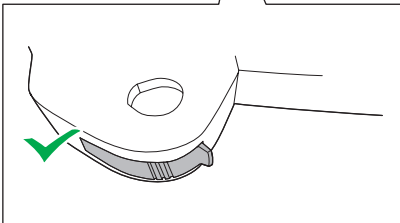
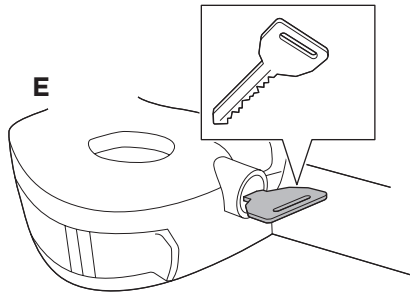

F

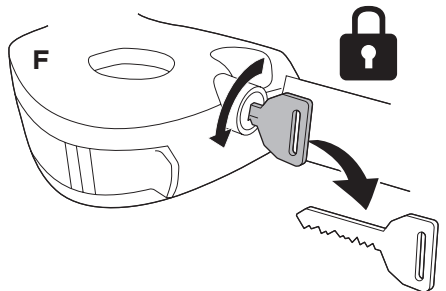

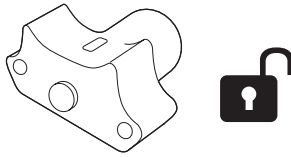

A

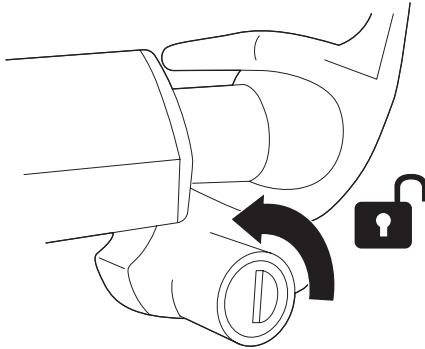

B

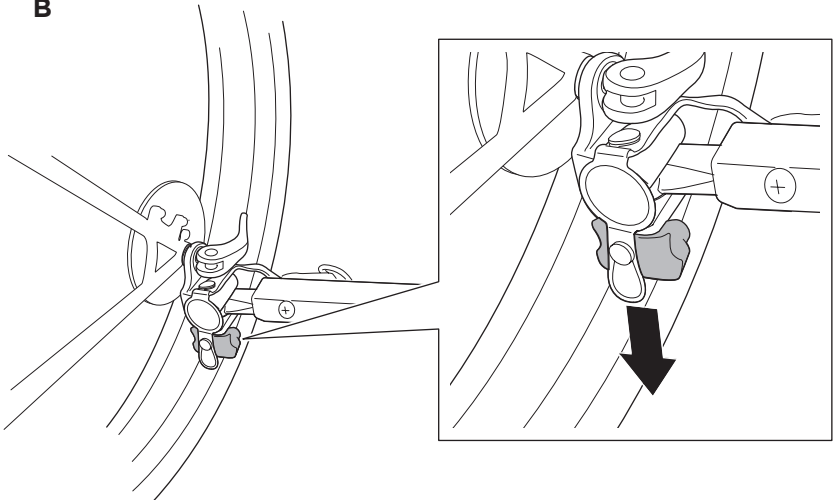

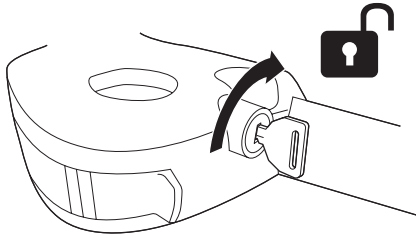
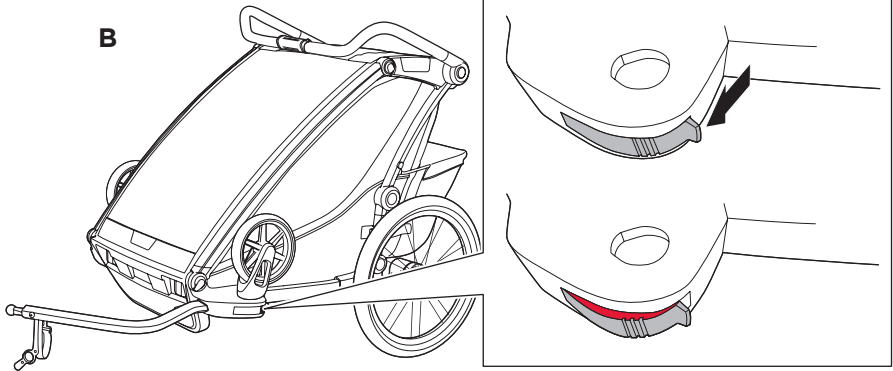
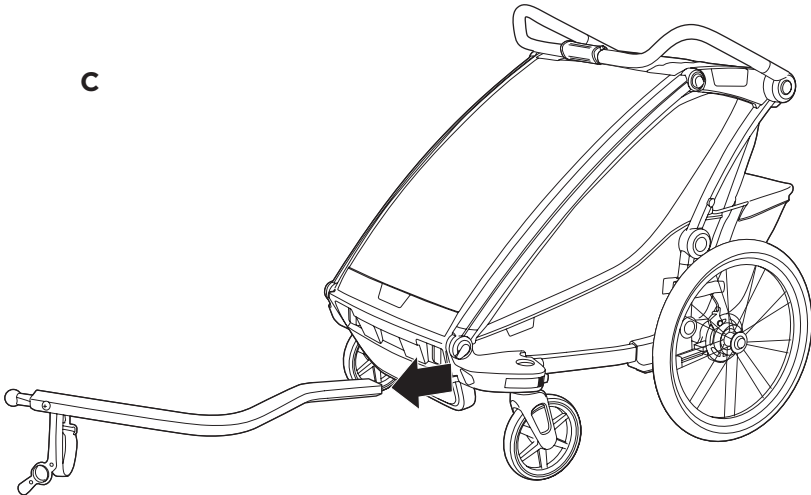
A**B****C**



Thule Sweden AB, Borggatan 5, 335 73 Hillerstorp, SWEDEN
Thule Inc., 42 Silvermine Road, Seymour, Connecticut 06483, USA



info@thule.com
Phone: 800-238-2388



www.thule.com