



Thule Rapid System Kit 4064 Thule Podium Kit 4064

> Instructions

FORD Fiesta Active, 5-dr Hatchback, 18-
FORD Galaxy, 5-dr MPV, 15-
FORD Mondeo (Mk. V), 5-dr Estate, 15-
FORD S-Max, 5-dr MPV, 15-

This kit is only for vehicles with flush side railing.

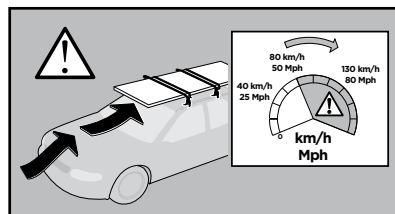
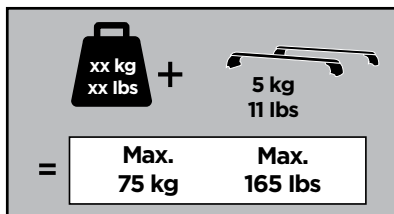
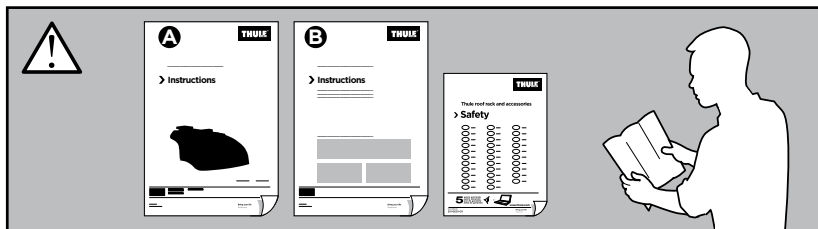

ISO 11154-E

184064
C.20180613
509-4064-05

Bring your life
thule.com

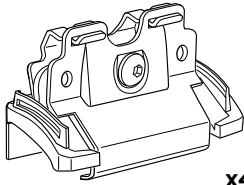

x4

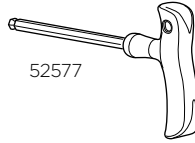

52577

x1

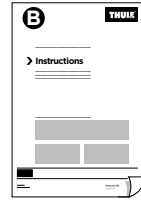

x1

1

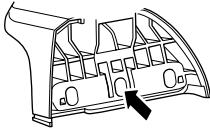

Thule Rapid System Foot Pack 753/7531
Thule Podium Foot Pack 460/460R

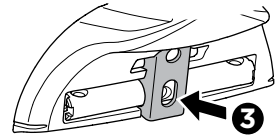
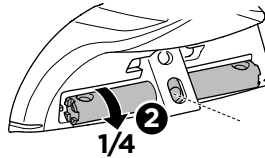
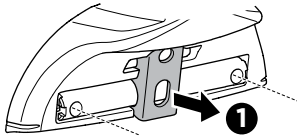

2

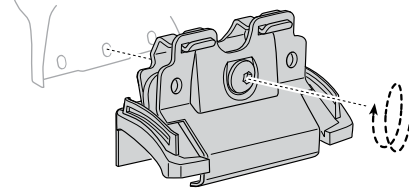

EN Only a few turns
DE Nur wenige Umdrehungen
FR Quelques tours uniquement
NL Slechts enkele slagen
IT Solo qualche giro
ES Sólo algunas vueltas
PT Apenas algumas voltas
SV Endast några varv
DK Kun nogle få omgange
NO Bare noen få omdreininger
FI Vain muutama kierros

ET Ainult mõni pööre
LV Tikai daži apgriezieni
LT Tik keli pasukimai
PL Wystarczy kilka obrotów
RU Только несколько оборотов
UK Лише декілька обертів
BG Само няколко завъртания
CS Pouze několik otáček
SK Len niekoľko otáčok
SL Le nekaj obratov
HR/BiH Samo nekoliko okreta
RO Doar câteva rotiri
HU Csak néhány fordítás
EL Μόνο λίγες περιστροφές
TR Yalnızca birkaç tur

بعض دورات فقط

AR

רק מספר סיבובים

HE

ZH 仅几圈
JA 2～3回転のみ
KO 몇 번만 돌리면 됨
TH เพียงสองสามรอบ

3

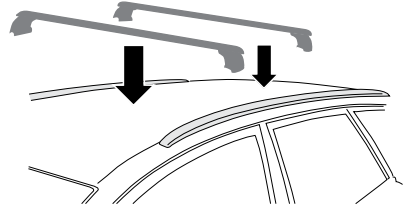
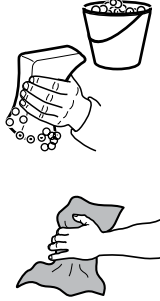
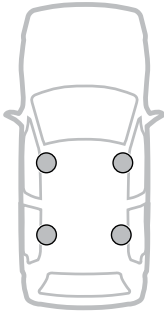

4

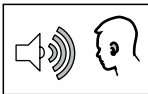
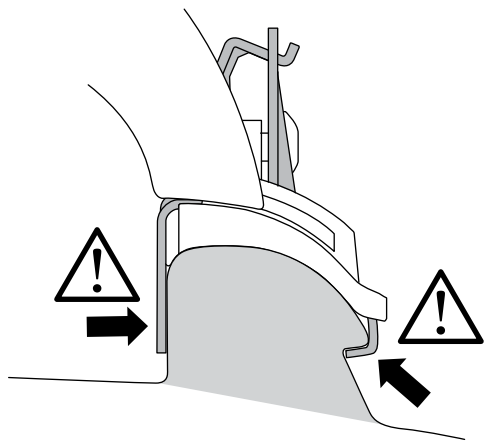
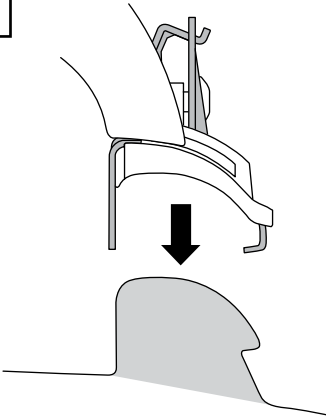

~ 700 mm

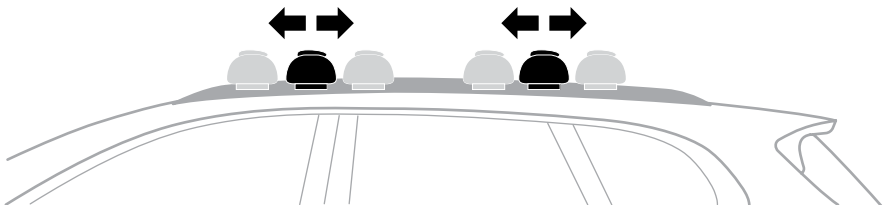
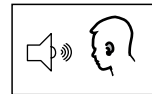

5

- | | | | |
|-----------|---|---------------|---|
| EN | Tighten alternately | UK | Затягти по чергово |
| DE | Die Schrauben abwechselnd anziehen | BG | Затегнете последователно |
| FR | Serrer alternativement chaque côté | CS | Pokřetla багаžníka dokřečaj dokřečaj naprzemiennie. |
| NL | Afwisselend aan de linker- en de rechterkant aandraaien | SK | Dotahujte striedavo |
| IT | Alternare il serraggio delle viti | SL | Privijajte izmenično |
| ES | Apretar alternativamente | HR/BIH | Naizmjenično zategnite |
| PT | Aperte alternadamente | RO | Strângeți alternativ |
| SV | Dra åt växelvis | HU | Egy mástól függetlenül szorítandó |
| DK | Spænd skiftevis | EL | Σφίγγετε εναλλάξ |
| NO | Trekk til vekselvis | TR | Dönüşümlü sıkın |
| FI | Kierrä vuorotellen | | |
| ET | Pinguldage vaheldumisi | | |
| LV | Pievelciet pamīšus | ZH | 交替拧紧 |
| LT | Užsukinėkite pakaitomis | JA | 自動固定 |
| PL | Śruby dokręcaj naprzemiennie | KO | 번갈아 조이기 |
| RU | Затягивайте попеременно | TH | ขันในแบบสลับ |

إحكام الربط بالتناوب **AR**חזק לסימון **HE**