

# Kit 1579

**KIA Cerato**, 4-dr Sedan, 08–

**KIA Forte**, 4-dr Sedan, 08– / \*10–

\*North America

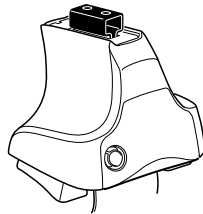

**754** Rapid System  
**480R** Rapid Traverse (North America)

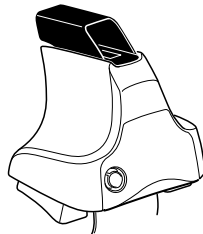
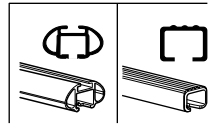

**480** Traverse (North America)

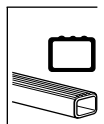



1

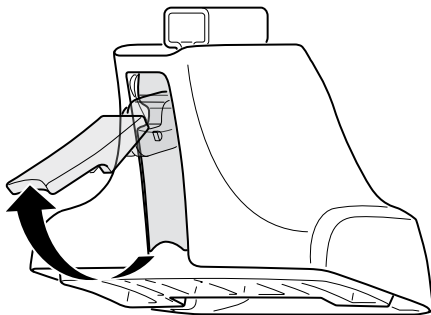

2



754 Rapid System  
480R Rapid Traverse  
(North America)

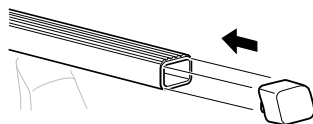
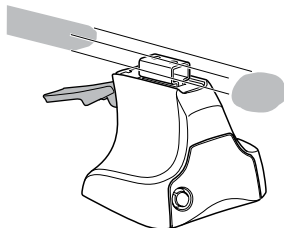

x4

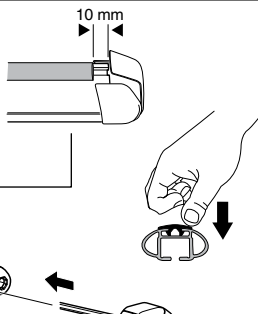
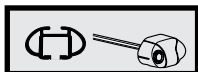

x4

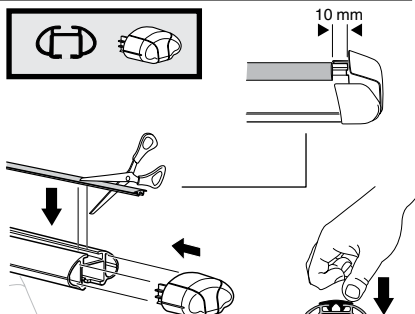
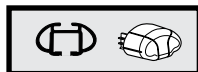

x4



480 Traverse  
(North America)

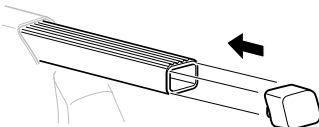

x4

**3**



**754** Rapid System

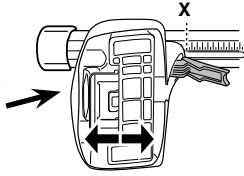

	X
<b>KIA Cerato, 4-dr Sedan, 08-</b>	<b>38,5</b>
<b>KIA Forte, 4-dr Sedan, 08- / *10-</b>	<b>38,5</b>

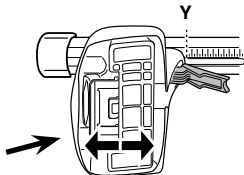

	Y
<b>KIA Cerato, 4-dr Sedan, 08-</b>	<b>36,5</b>
<b>KIA Forte, 4-dr Sedan, 08- / *10-</b>	<b>36,5</b>

**3**



**480R** Rapid Traverse



**480** Traverse



**(North America)**

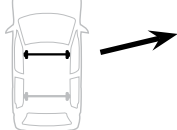

	X inch	X mm
<b>KIA Cerato, 4-dr Sedan, 08-</b>	<b>40 3/4"</b>	<b>1036 mm</b>
<b>KIA Forte, 4-dr Sedan, 08- / *10-</b>	<b>40 3/4"</b>	<b>1036 mm</b>

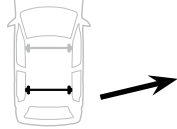

	Y inch	Y mm
<b>KIA Cerato, 4-dr Sedan, 08-</b>	<b>40"</b>	<b>1015 mm</b>
<b>KIA Forte, 4-dr Sedan, 08- / *10-</b>	<b>40"</b>	<b>1015 mm</b>

**4**

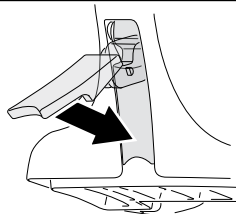

**5**

**KIA Cerato, 4-dr Sedan, 08–**  
**KIA Forte, 4-dr Sedan, 08– / \*10–**

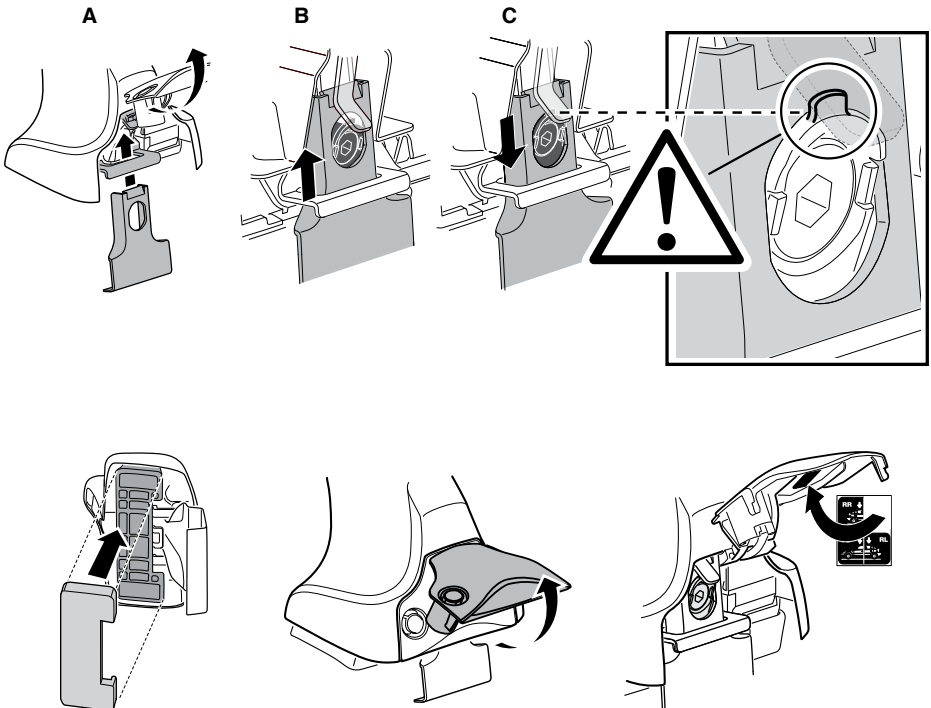
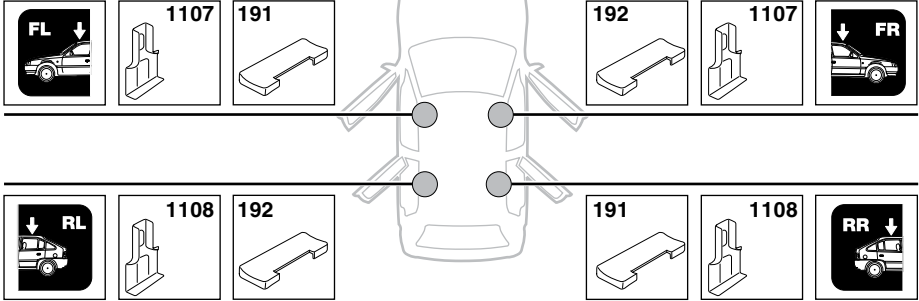

6

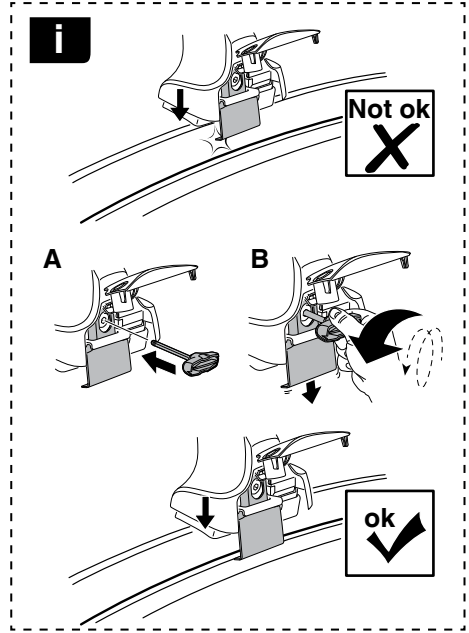
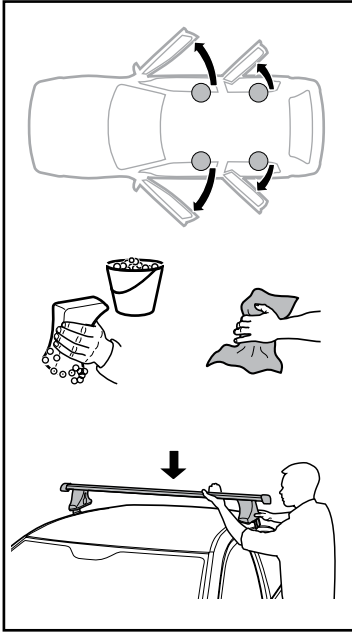

	X mm	Y mm	X inch	Y inch
KIA Cerato, 4-dr Sedan, 08-	260 mm	660 mm	10 1/4"	26"
KIA Forte, 4-dr Sedan, 08- / *10-	260 mm	660 mm	10 1/4"	26"

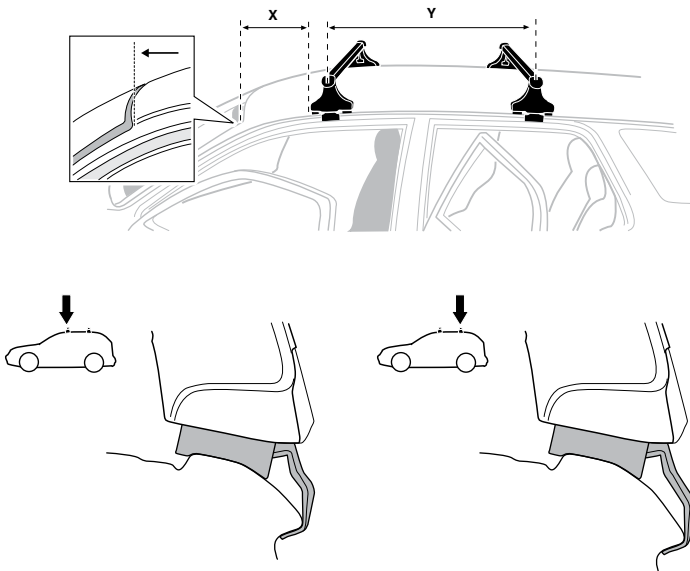

7

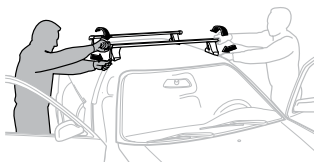

**GB/US** Tighten alternately  
**D** Die Schrauben abwechselnd anziehen  
**F** Serrer alternativement chaque côté  
**NL** Afwisselend aan de linker- en de rechterkant aandraaien  
**I** Alternare il serraggio delle viti  
**E** Apertar alternativamente  
**PT** Aperte alternadamente  
**S** Dra åt växelvis  
**FIN** Kierrä vuorotellen  
**EST** Pinguldage vaheldumisi  
**LAT** Pieļieciet pamišus  
**LIT** Užsukinėkite pakaitomis  
**PL** Śruby dokręcaj naprzemiennie  
**RU** Затягивайте попеременно

**CZ** Pokręťta bagażnika dokręcaj naprzemiennie.  
**SK** Dofahajte striedavo  
**SLO** Privijajte izmenično.  
**HR** Naizmjerno zategnite  
**HU** Egymástól függetlenül szorítandó  
**GR** Σφιγίγτες εναλλάξ  
**TR** Dönüşümlü sıkın

**中文** 交替拧紧

**한국어** 번갈아 가며 조이십시오.

**日本語** 交互に締め付けてください。

**ไทย** ชันในแบบสลับ

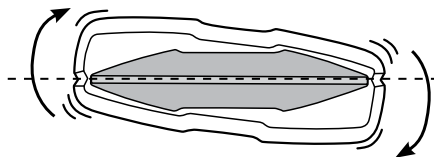
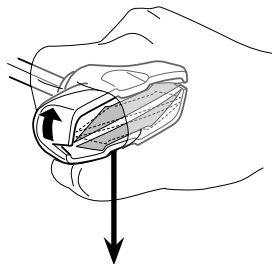
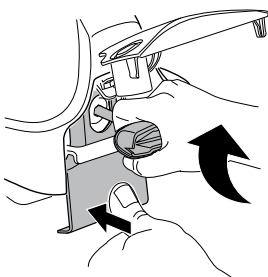
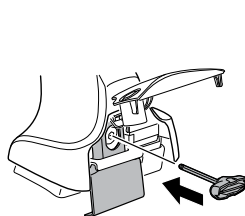

≈ 3 Nm

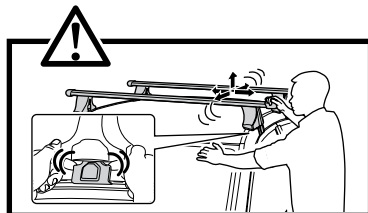
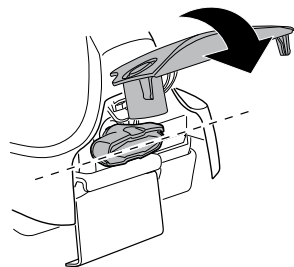

8



x1  
17 mm

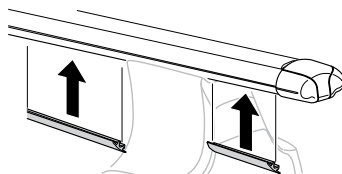
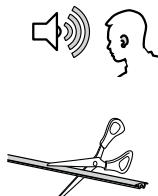

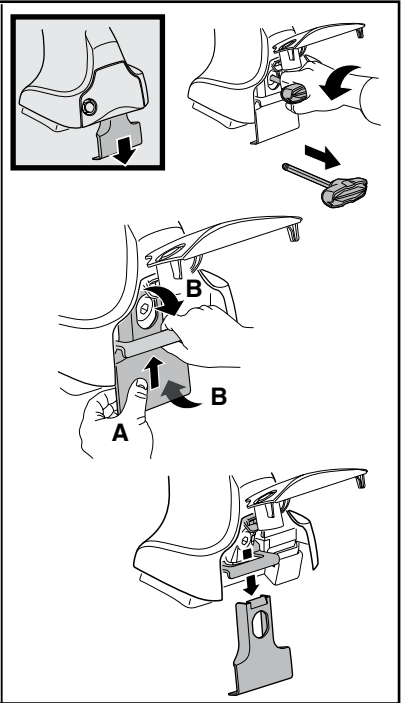
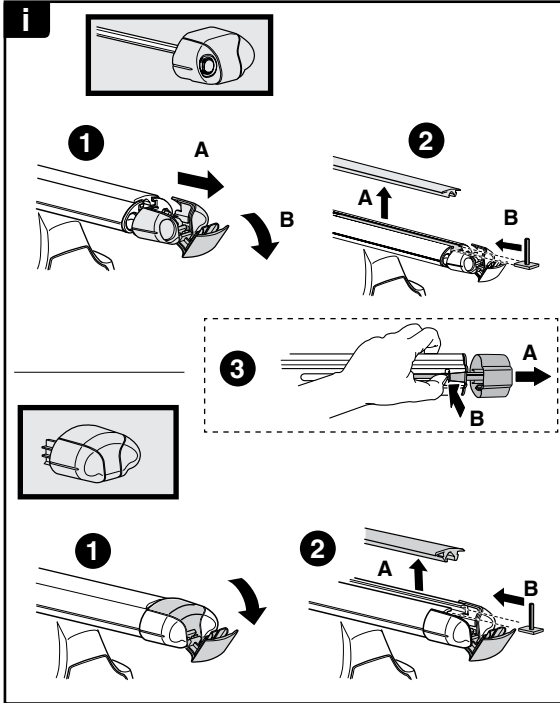

**THULE**  
SWEDEN  
**ONE  
KEY  
SYSTEM**



		(x4)
		(x6)
		(x8)
NA		(x10)
EUR		(x12)
ASIA		



WW ▶ Thule Sweden AB, Box 69, 330 33 Hillerstorp, SWEDEN  
NA ▶ Thule Inc., 42 Silvermine Road, Seymour, Connecticut 06483, USA

info@thule.com  
customer.service@thule.com

www.thule.com